

# Similar Figures

Each pair of figures is similar. Find the missing side. *4 measure all the angles for #'s 1-8. What do you notice*

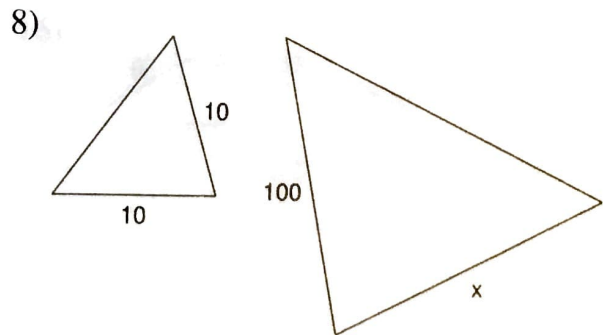

9)

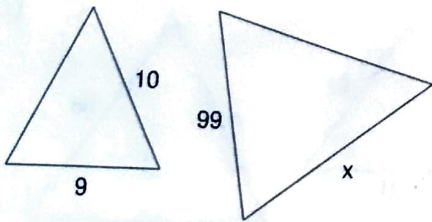
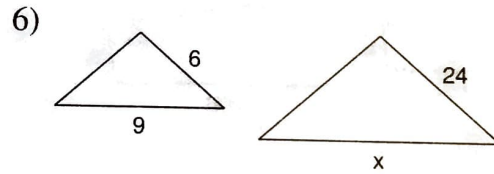
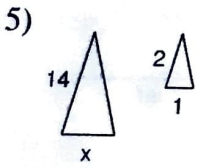
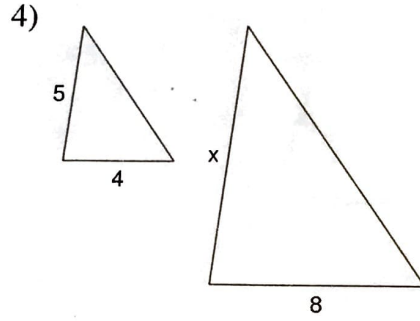
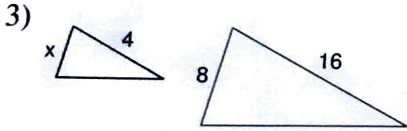
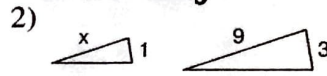
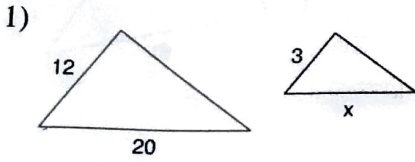
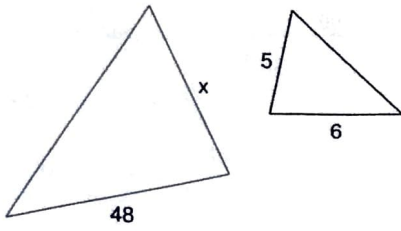

10)

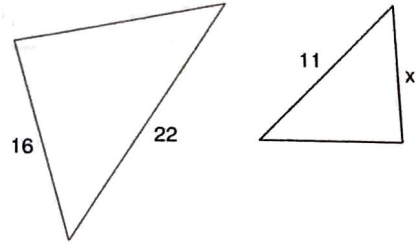

11)

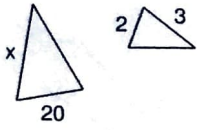

12)

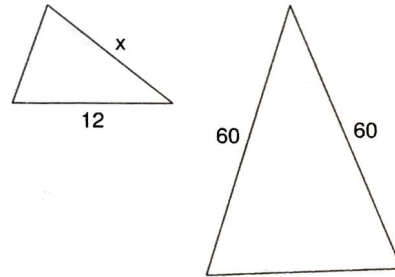

13)

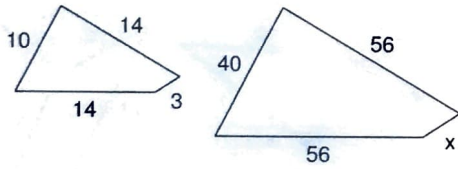

14)

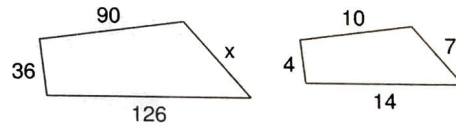

15)

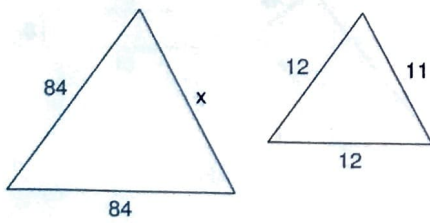

16)

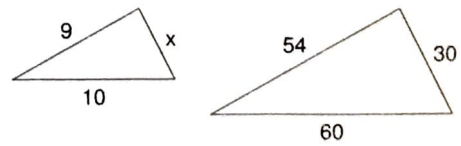

17)

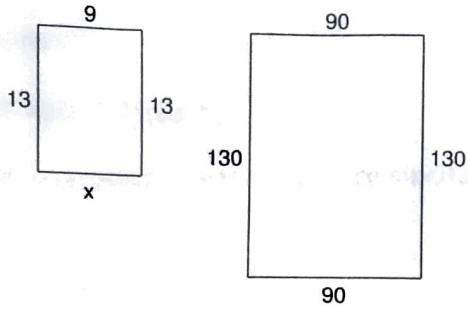

18)

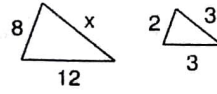

19)

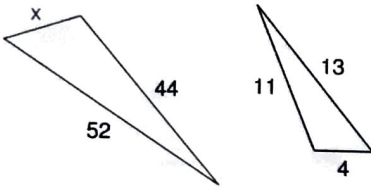

20)

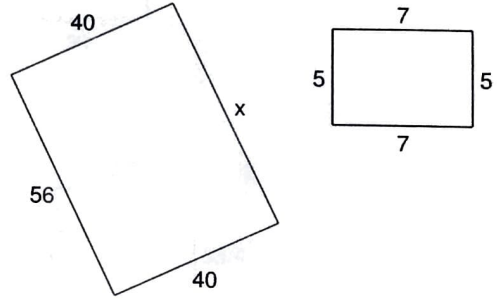

21)

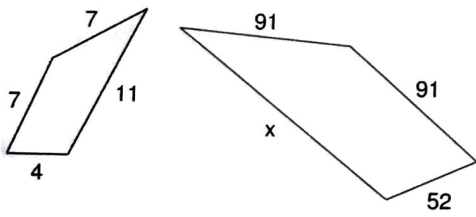

22)

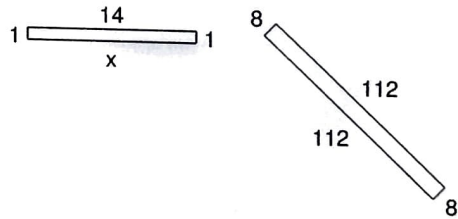

23)

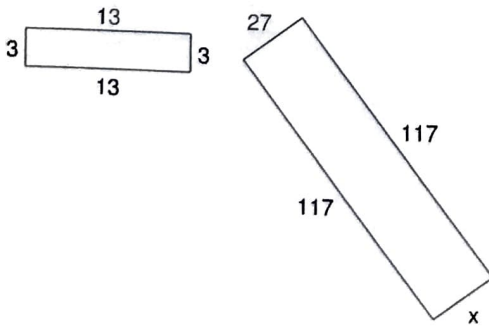

24)

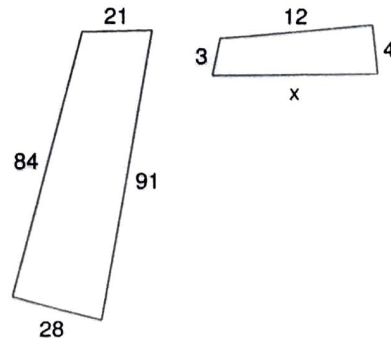

Similar Figures

The polygons in each pair are similar. Find the scale factor of the smaller figure to the larger figure.

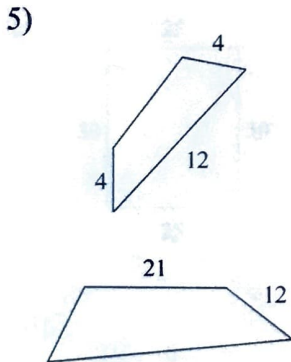
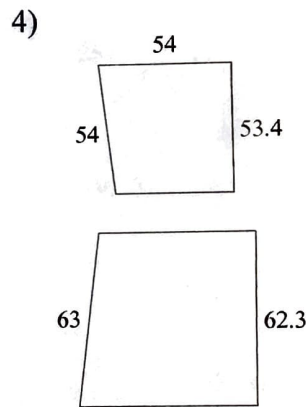
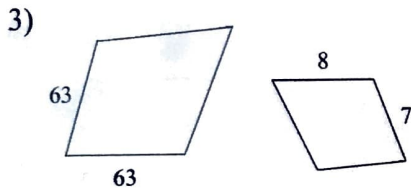
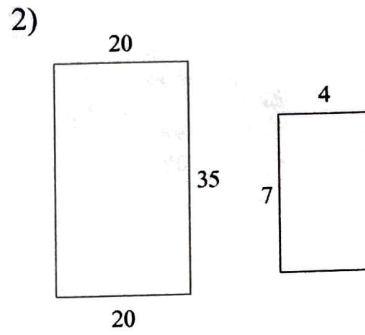
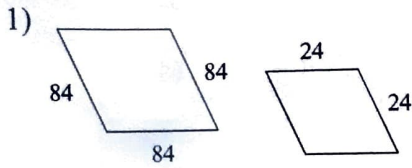

State if the polygons are similar.

6)

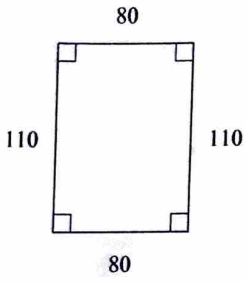
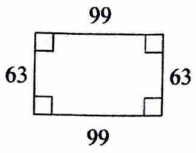

8)

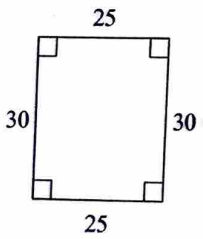
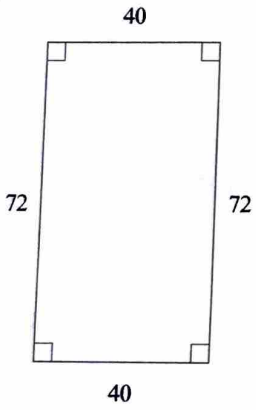

10)

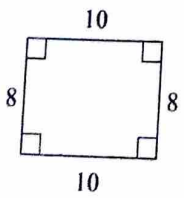
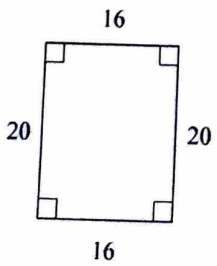

7)

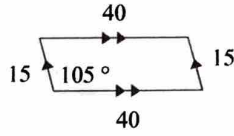
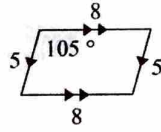

9)

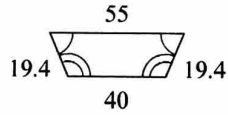
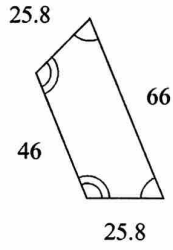

The polygons in each pair are similar. Find the missing side length.

11)

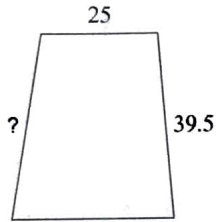
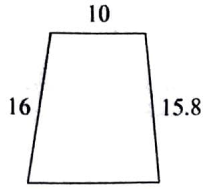

12)

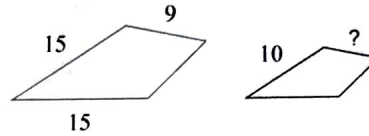

13)

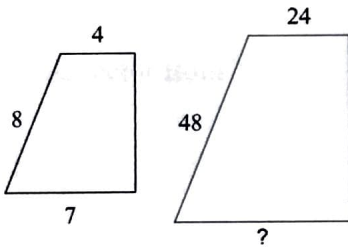

14)

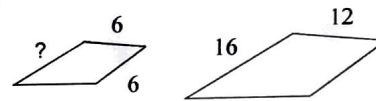

15)

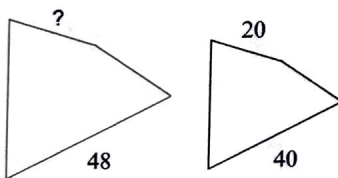

Solve for  $x$ . The polygons in each pair are similar.

16)

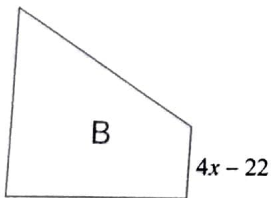
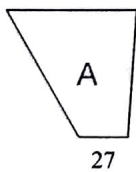

scale factor from A to B = 9 : 10

17)

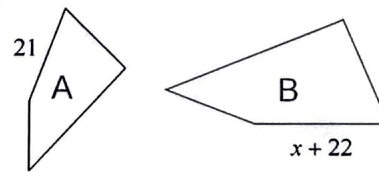

scale factor from A to B = 3 : 5

18)



scale factor from A to B = 3 : 4

19)

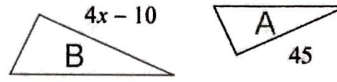

scale factor from A to B = 5 : 6

20)

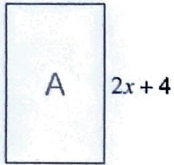
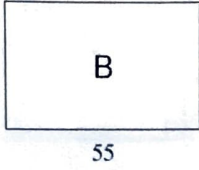

scale factor from A to B = 4 : 5

### Similar Right Triangles

Find the missing length indicated. Leave your answer in simplest radical form.

1)

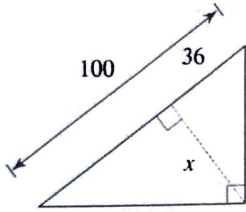

2)

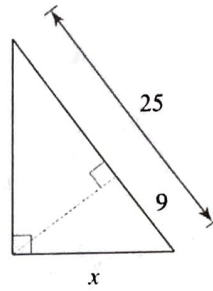

3)

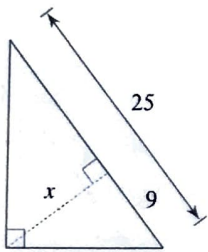

4)

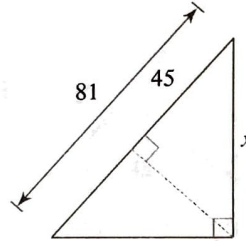

5)

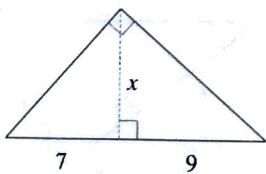

6)

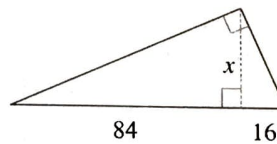

7)

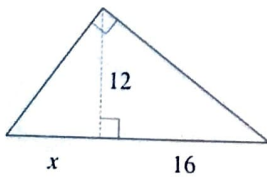

8)

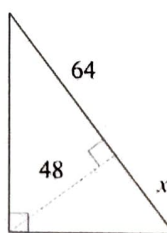



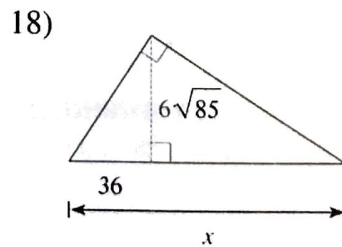
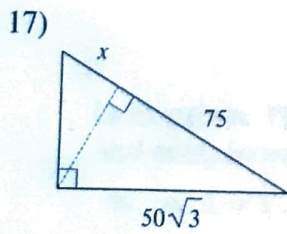
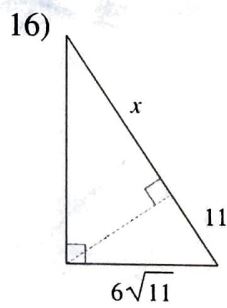
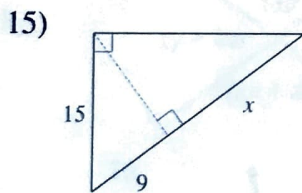
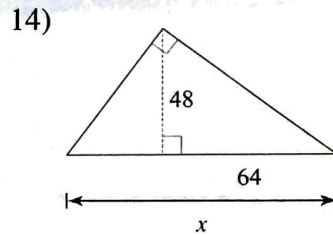
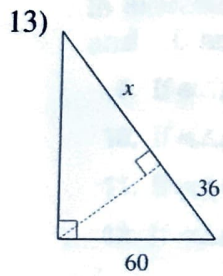
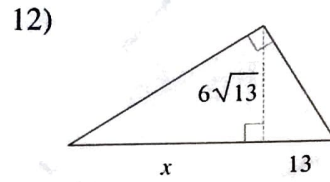
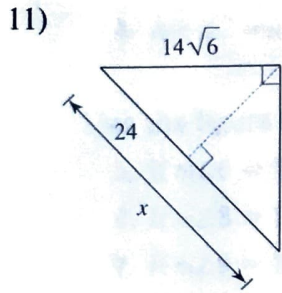
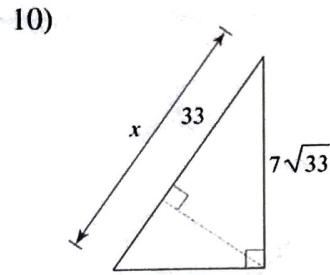
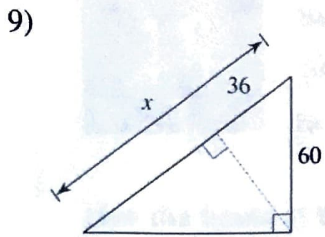

**Practice B**

For use with pages 44-50

Use the figure at the right.

- Are  $\angle 1$  and  $\angle 2$  a linear pair?
- Are  $\angle 4$  and  $\angle 5$  a linear pair?
- Are  $\angle 3$  and  $\angle 1$  vertical angles?
- Are  $\angle 2$  and  $\angle 5$  vertical angles?

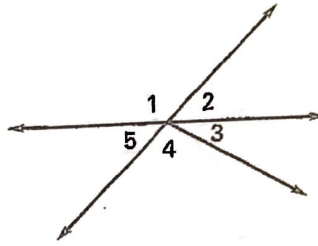

Use the figure at the right.

- If  $m\angle 6 = 51^\circ$ , then  $m\angle 7 = ?$ .
- If  $m\angle 8 = 103^\circ$ , then  $m\angle 6 = ?$ .
- If  $m\angle 9 = 136^\circ$ , then  $m\angle 8 = ?$ .
- If  $m\angle 7 = 53^\circ$ , then  $m\angle 9 = ?$ .

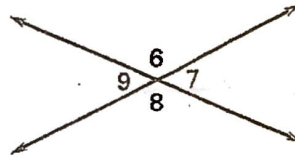

In Exercises 9-12, assume  $\angle A$  and  $\angle B$  are complementary and  $\angle B$  and  $\angle C$  are supplementary.

- If  $m\angle A = 48^\circ$ , then  $m\angle B = ?$  and  $m\angle C = ?$ .
- If  $m\angle B = 83^\circ$ , then  $m\angle A = ?$  and  $m\angle C = ?$ .
- If  $m\angle C = 127^\circ$ , then  $m\angle B = ?$  and  $m\angle A = ?$ .
- If  $m\angle A = 45^\circ$ , then  $m\angle B = ?$  and  $m\angle C = ?$ .

Find the value(s) of the variable(s).

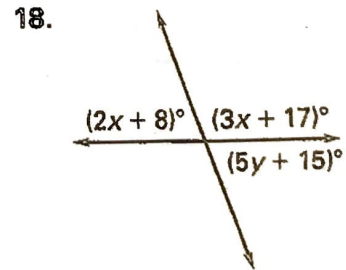
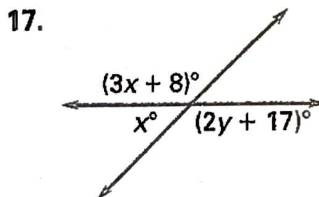
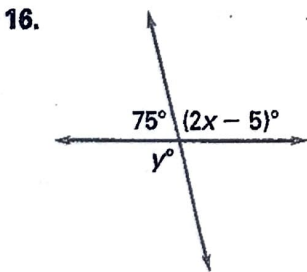
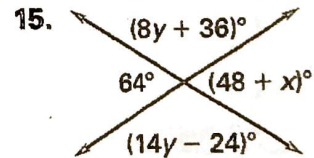
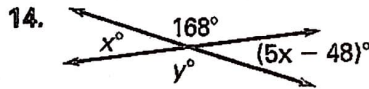
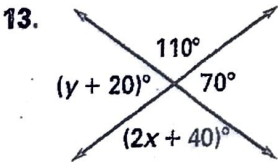

In Exercises 19 and 20, assume that  $\angle A$  is supplementary to  $\angle B$  and complementary to  $\angle C$ . Determine  $m\angle A$ ,  $m\angle B$ , and  $m\angle C$ .

- $m\angle A = x^\circ$ ,  $m\angle B = (x + 40)^\circ$ ,  $m\angle C = (x - 50)^\circ$
- $m\angle A = x^\circ$ ,  $m\angle B = (2x)^\circ$ ,  $m\angle C = (x - 30)^\circ$

20

**Practice A**

For use with pages 143-149

Name the relationship between the pair of angles.

1.  $\angle 1$  and  $\angle 5$
2.  $\angle 2$  and  $\angle 7$
3.  $\angle 3$  and  $\angle 6$
4.  $\angle 8$  and  $\angle 5$
5.  $\angle 4$  and  $\angle 6$
6.  $\angle 8$  and  $\angle 4$

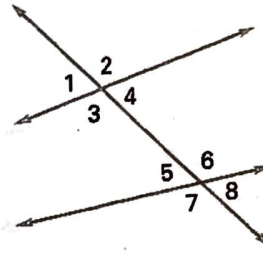

State the postulate or theorem that justifies the statement.

7.  $\angle 3 \cong \angle 7$
8.  $\angle 3 \cong \angle 6$
9.  $\angle 2 \cong \angle 7$
10.  $m\angle 4 + m\angle 6 = 180^\circ$

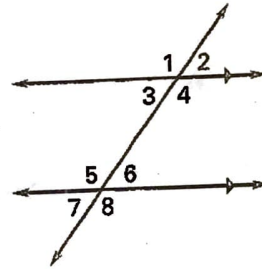

Find the values of  $x$  and  $y$ .

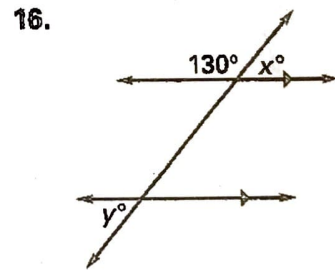
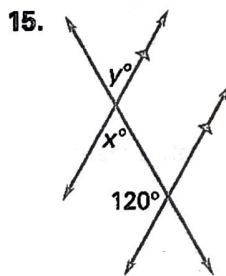
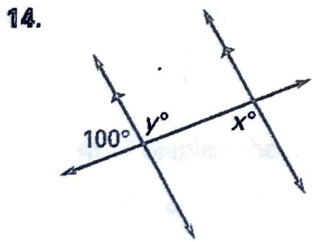
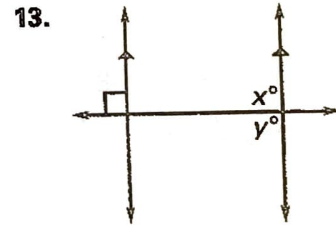
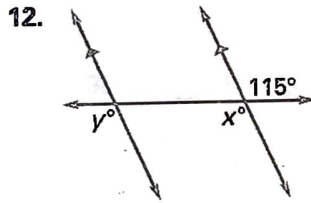
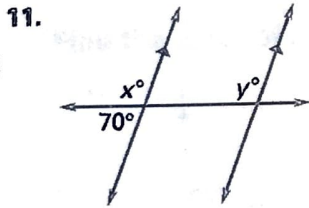

Lesson 3.3

Find the value of  $x$ .

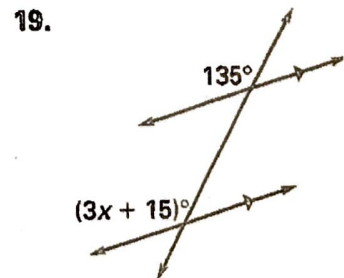
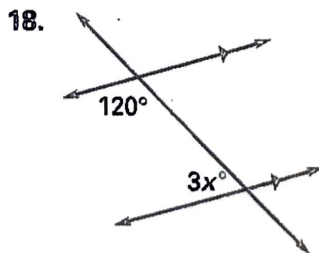
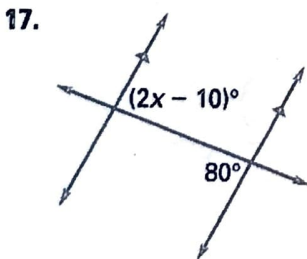

21

**Practice B**

For use with pages 143–149

Find  $m\angle 1$  and  $m\angle 2$ . Explain your reasoning.

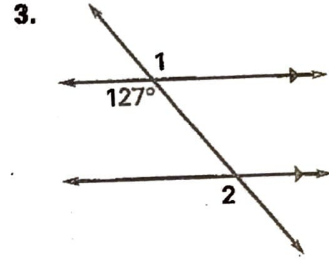
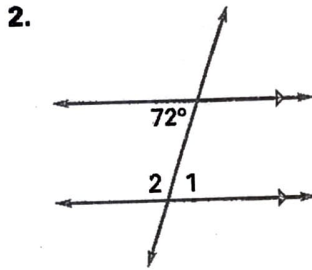
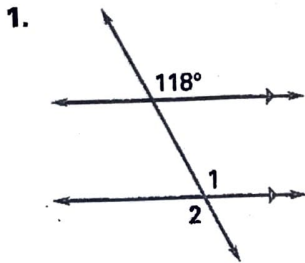

Find the values of  $x$  and  $y$ .

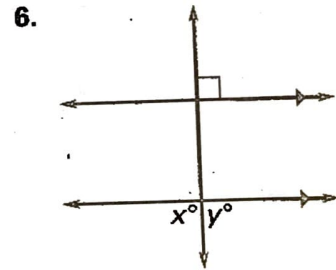
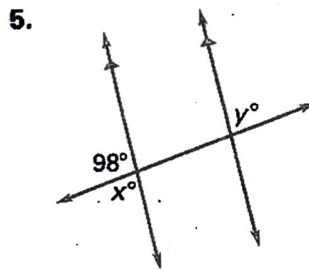
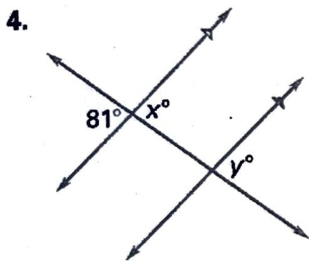

Find the value of  $x$ .

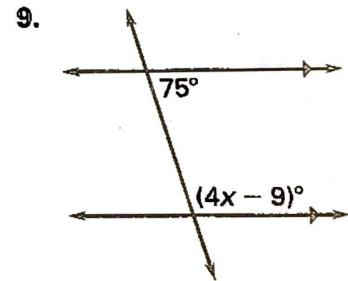
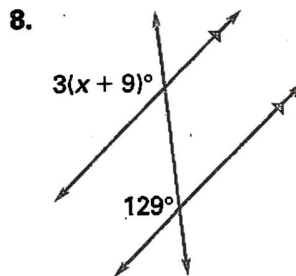
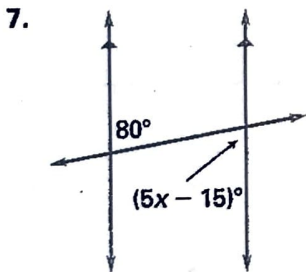

10. Complete the flow proof of the Alternate Exterior Angles Theorem.

Given:  $l \parallel m$

Prove:  $\angle 1 \cong \angle 2$

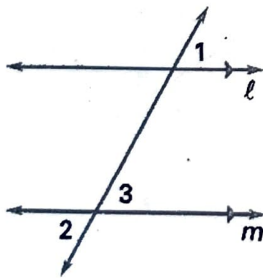

$l \parallel m$

a. \_\_\_\_\_

$\angle 1 \cong \angle 3$

$\angle 3 \cong \angle 2$

b. \_\_\_\_\_

c. \_\_\_\_\_

$\angle 1 \cong \angle 2$

d. \_\_\_\_\_

Lesson 3.3

22



Parallel Lines and Transversals

Identify each pair of angles as corresponding, alternate interior, alternate exterior, or consecutive interior.

1)

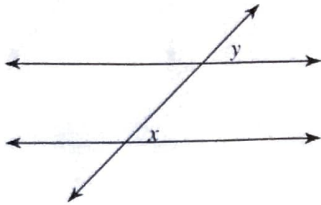

2)

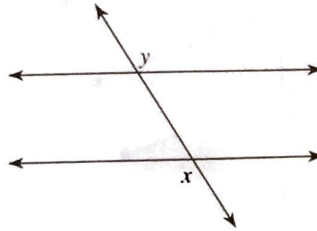

3)

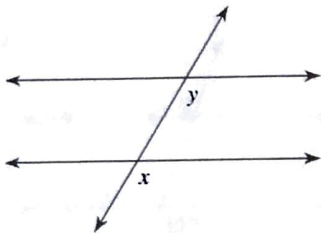

4)

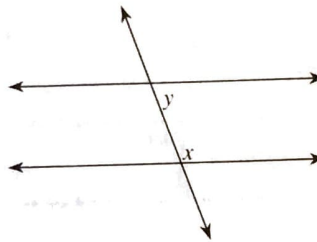

5)

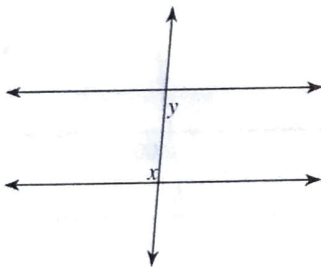

6)

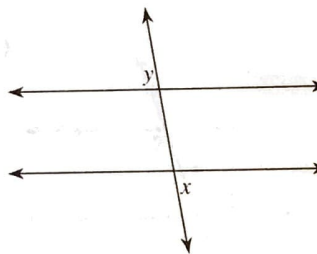

7)

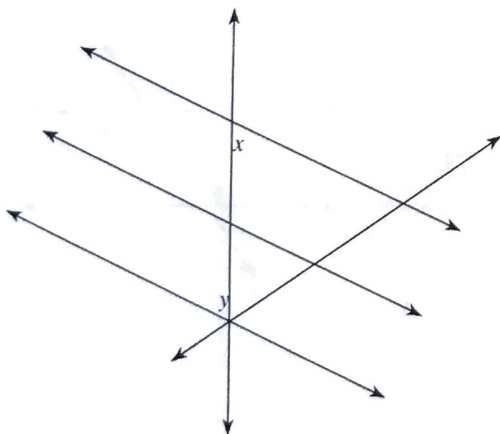

8)

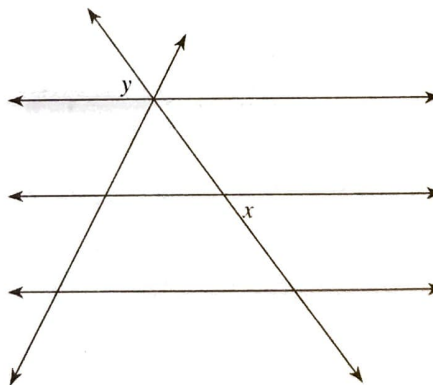

9)

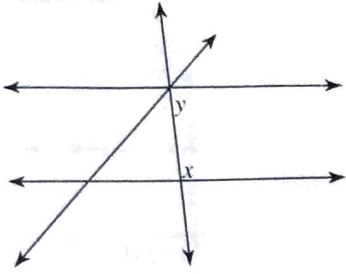

10)

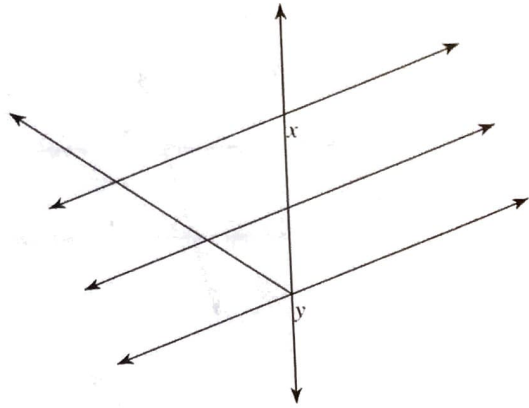

Find the measure of each angle indicated.

11)

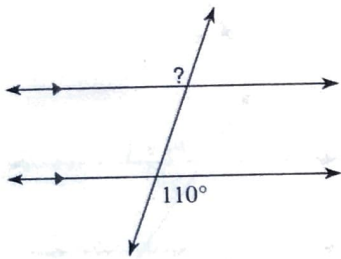

12)

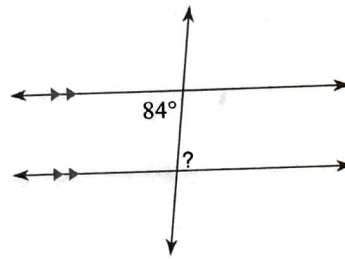

13)

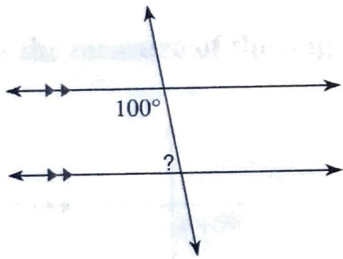

14)

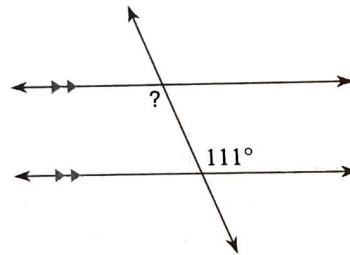

15)

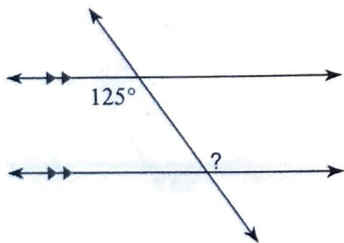

16)

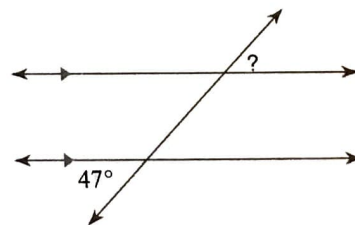

17)

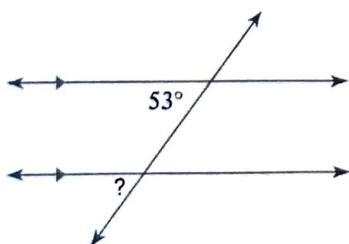

18)

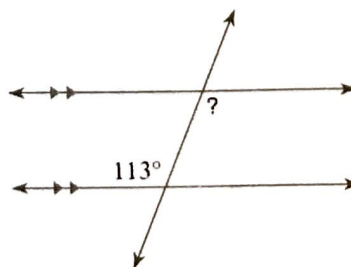

Solve for  $x$ .

19)

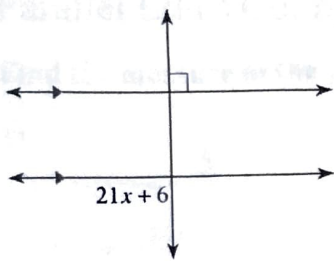

20)

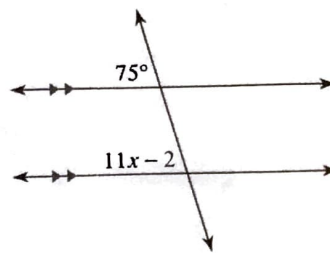

21)

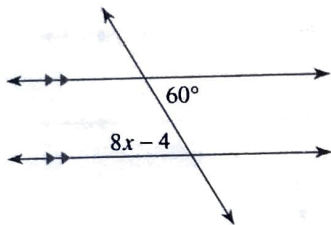

22)

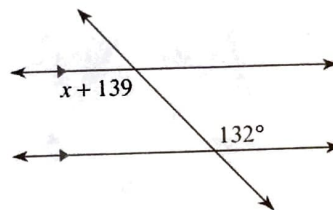

23)

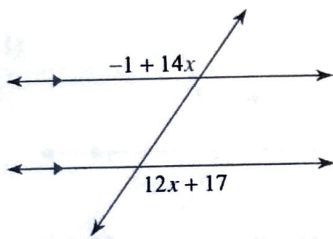

24)

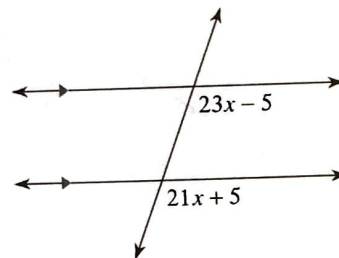

Find the measure of the angle indicated in bold.

25)

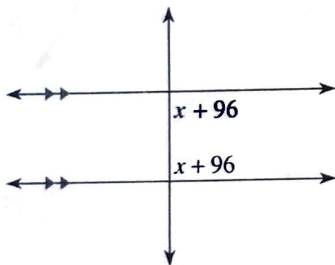

26)

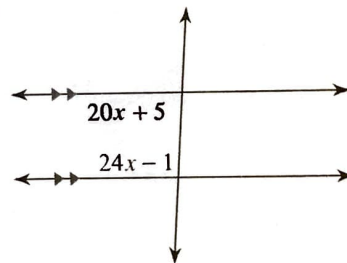

27)

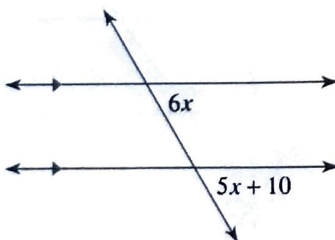

28)

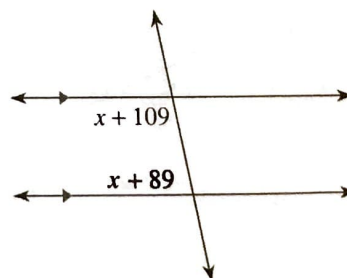

Parallel Lines Cut by Transversals

Find the measure of the angle indicated in bold.

1)

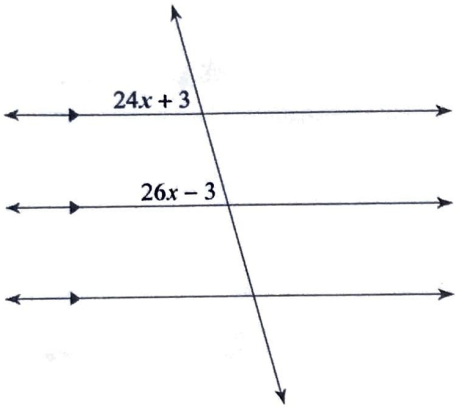

2)

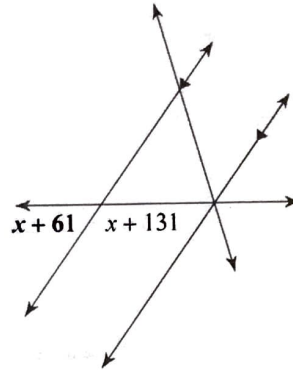

3)

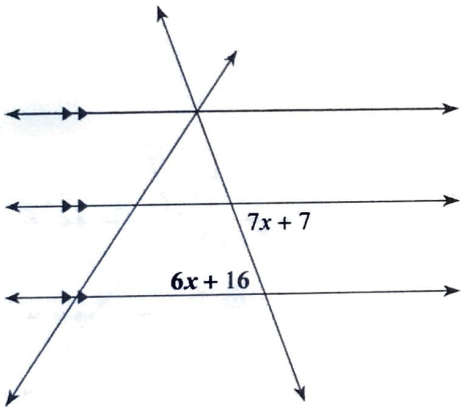

4)

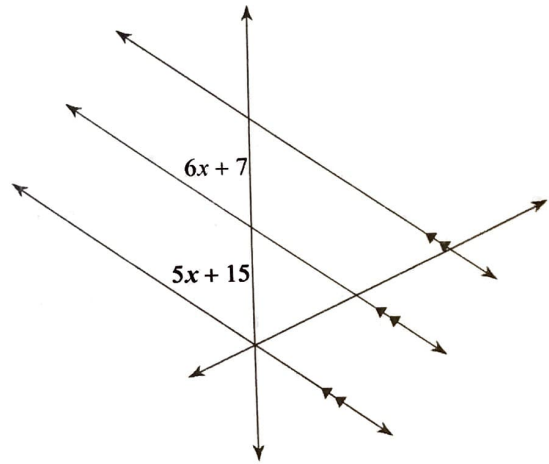

5)

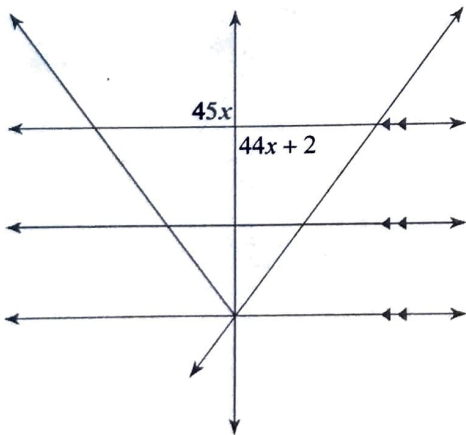

6)

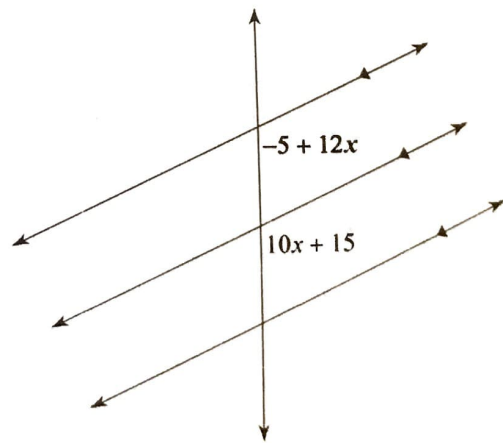



7)

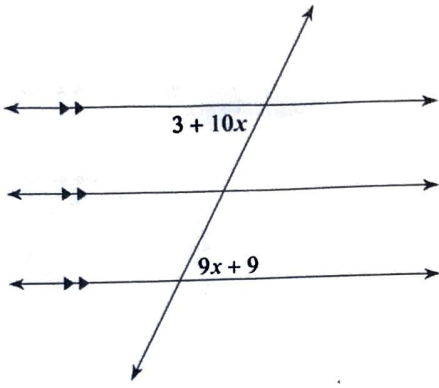

8)

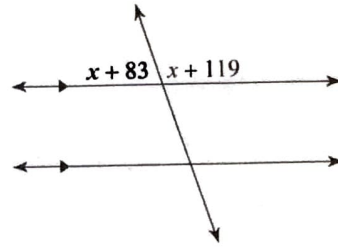

9)

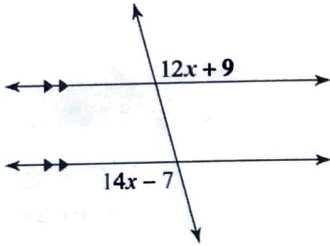

10)

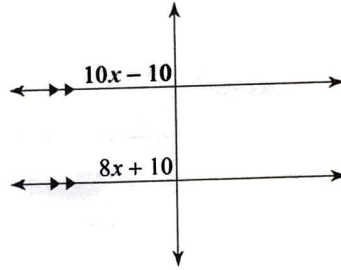

11)

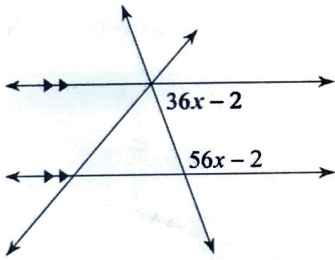

12)

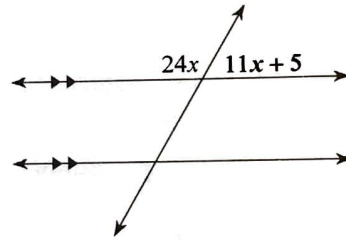

13)

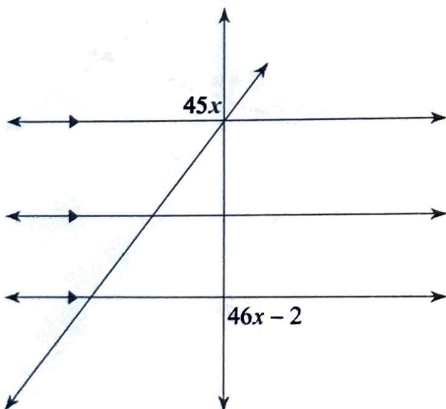

14)

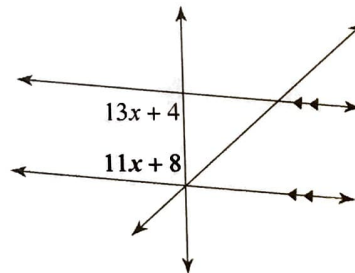

15)

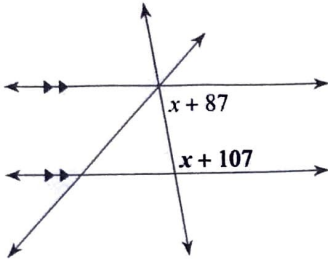

16)

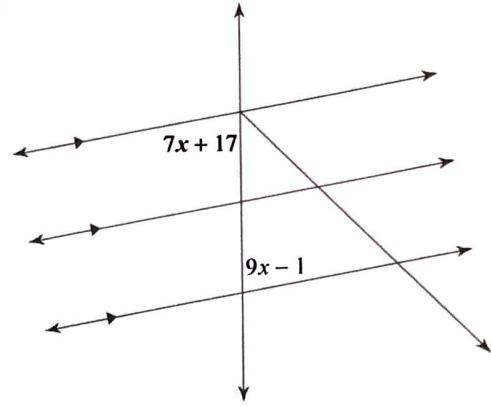

17)

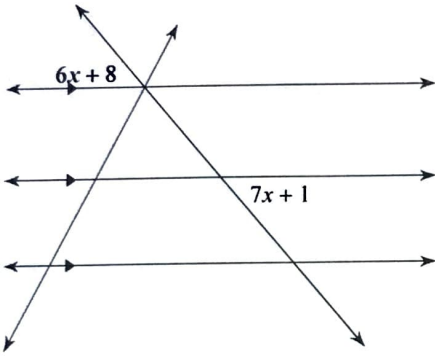

18)

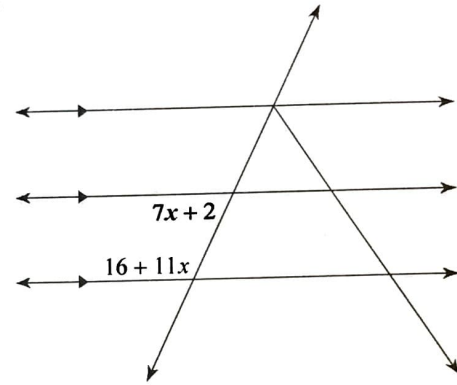

19)

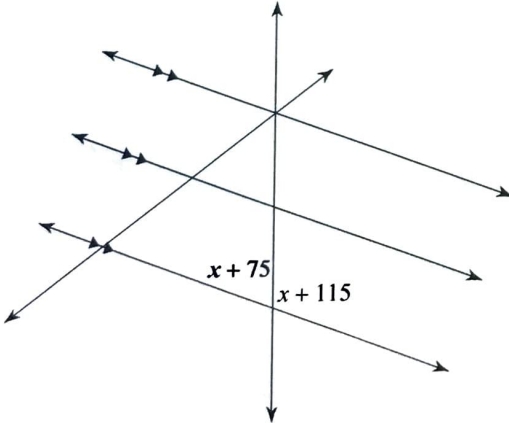

20)

